

LJUDDÄMPANDE SPALTVENTIL VENTEC VT 401

I GENOMSKÄRNING VT 400

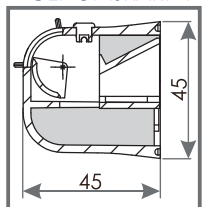

LJUDDÄMPANDE SPALTVENTIL VT 400

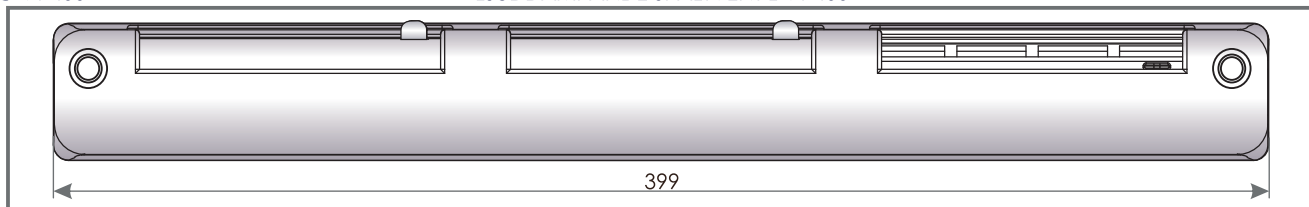

I GENOMSKÄRNING OZ 400

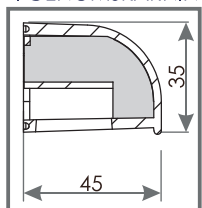

LJUDDÄMPANDE UTEDEL OZ 400

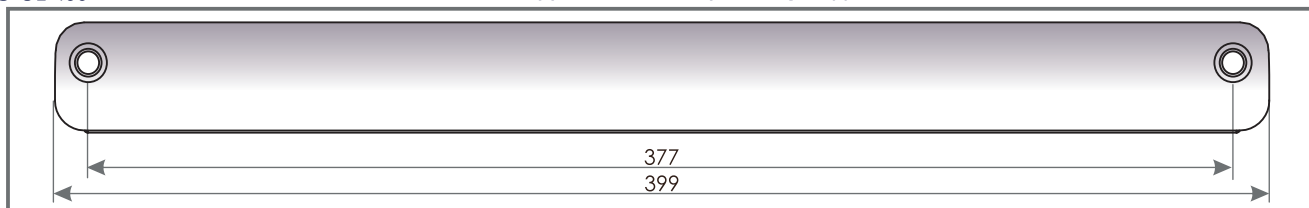

TEKNISKA EGENSKAPER

Luffflöde

23 m³/h ($\Delta p = 10$ Pa)

Ljudisolering

$D_{n,e,w} (C;C_{tr}) = 40 (0;-1)$ dB

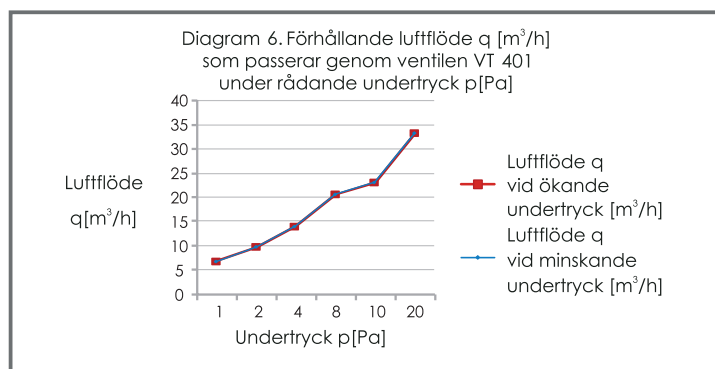

MONTERINGSANVISNING

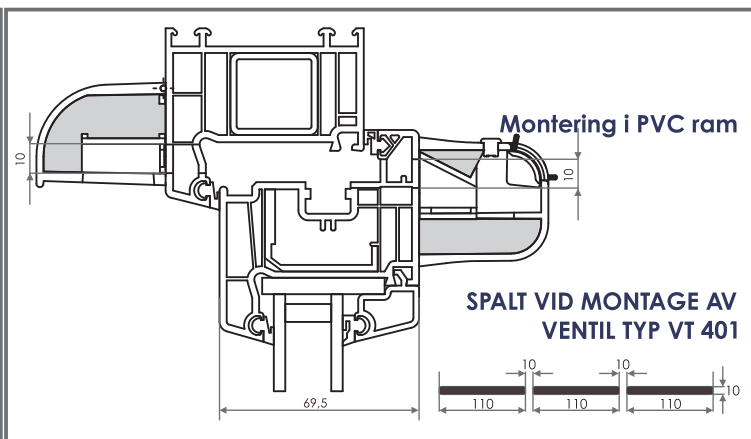
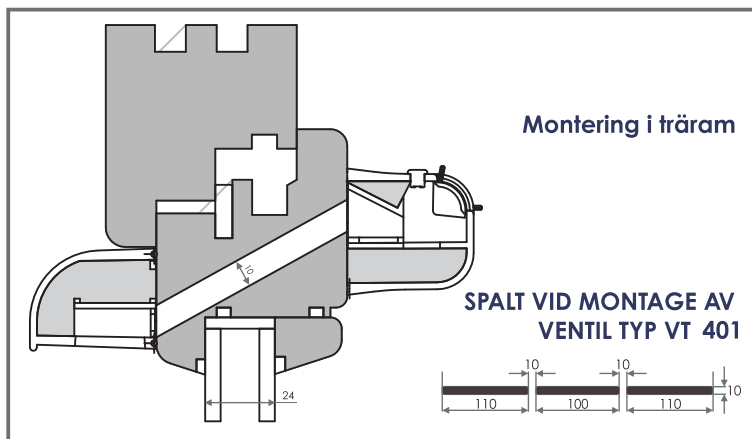

VENTEC VT 401 - finns tillgänglig i följande färger

Ventil modell	VT401	VT412	VT413	VT414	VT415	VT422	VT423	VT424	VT425
Färger innedel	RAL 9003	RAL 9003	RAL 9003	RAL 9003	RAL 9003	RAL 8001	RAL 8017	RAL 7047	RAL 7016
Färger utedel	RAL 9003	RAL 8001	RAL 8017	RAL 7047	RAL 7016	RAL 8001	RAL 8017	RAL 7047	RAL 7016